

Inter light

45W



Intended Applications

- Indoor Farming;
- Vegetable Cultivation;

Features & Benefits

- Constant current drive, long lifetime.
- IP65 waterproof rating for the whole fixtures, suitable for high humidity environment application.
- Flicker free, good for eyes.
- Application environment: mainly used in indoor cultivation.

Inter light

45W PPE 2.5 μ mol/J

Features & Benefits

Input Power	45W
Photosynthetic photon flux	112 μ mol/s
PAR Efficacy	2.5 μ mol/J
Light Emission Angle	110°
Color Rendering Index	>90
Input Voltage	100-277Vac 50/60Hz
Amp Draw	0.40A@120V, 0.23A@220V, 0.21A@240V, 0.19A@277V
Power Factor	>0.9
Total Harmonic Distortion	<20%
Driver Surge protection	1KV
LED Type	5600K 660nm
Housing	Aluminum Alloy+Plastic
Housing Color	White+Blue
Heat Output	137 BTU
IP Rating	IP65 waterproof rating for the whole fixtures
Operating Temperature	-10~40°C
Operating Humidity	10%-90% RH
Storage Temperature	-25~60°C
Storage Humidity	10%-90% RH
Warranty Time	5years
N.W(KG)	1.3Kg(2.87LBS)
G.W(KG)	1.8Kg(3.97LBS)
Packing Dimension(mm)	1430*75*75mm

Dimension Drawing

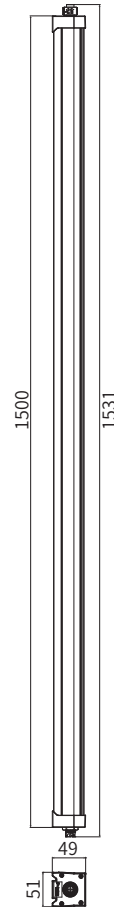

Length(L)	1500mm (59.06")
Width(W)	51mm (2.01")
Height(H)	49mm (1.93")



Spectral Distribution

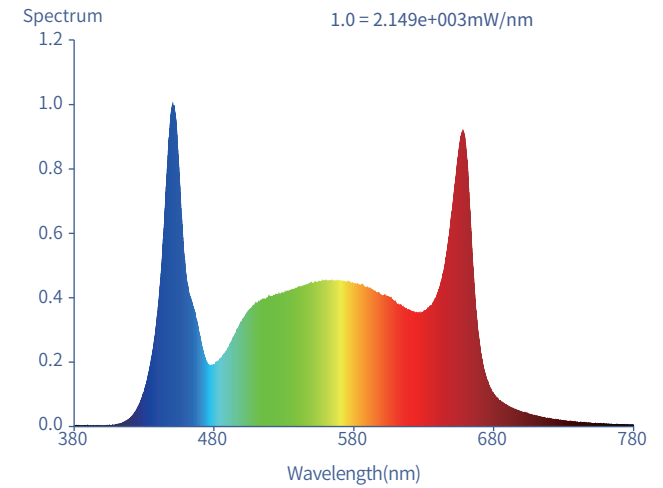

PPFD Reading -- 4FT to 4FT area

83	95	101	102	100	101	95	81
86	98	108	110	110	107	97	88
85	97	104	107	109	107	101	85
80	89	96	98	97	94	90	83

0.60m 24"

83	91	103	103	104	106	97	85
102	120	133	130	130	127	118	103
108	122	133	137	132	131	120	110
85	98	108	110	109	104	102	90

0.45m 18"

86	100	113	118	119	118	111	91
142	178	191	195	188	190	176	145
137	174	188	188	183	182	169	144
85	106	109	112	110	115	106	85

0.30m 12"

Performance Data

Model	Input Voltage	Input Power	PPF	PPE	FCC
DM1-A15-45-A66-A8	100-277Vac	45W	112 μ mol/s	2.5 μ mol/J	Yes

Installation & Usage Guide

WARNING AND CAUTION

- > Please read the following instructions carefully before using this grow lighting fixture.
- > Make sure mains power is switched off before connecting the light fixture.
- > Don not connect or disconnect the LED fixture under load.
- > Always allow for a cool down period of at least 30 minutes before touching the LED fixture.
- > Please DO NOT use this product outdoors.
- > Connect the cables according to local rules, safety regulations and electrical code.
- > Mounting and installing of the LED fixture may only be executed by certified service person,in accordance with the applicable local laws and regulations.

PLANNING THE INSTALLATION

Read all instructions before installation. Before starting installation of this fixture or removal of a previous fixture,disconnect the power by turning of circuit breaker or by removing the fuse at the fuse box.

01



Light module-1PCS (A)



Fixing clip-1PCS (B)

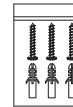

Accessories bag-1PCS (C)

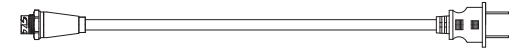

AC cord-1pcs (D)

- Main part & Accessory

02



- Take the light module out of the box (A).

03

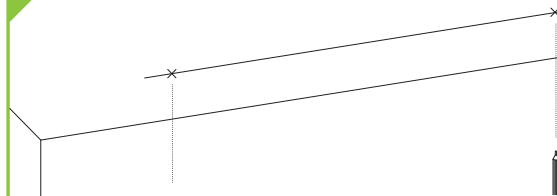

- Make marks and then punch holes accordingly on the wall.

04

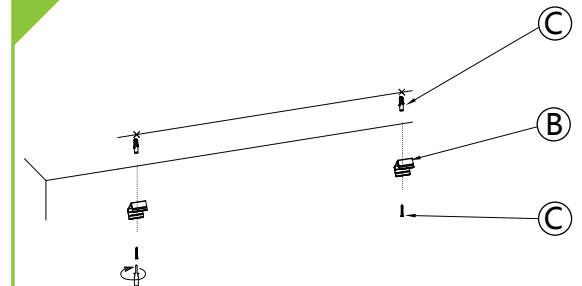

- Install the expansion tube, screw (C) and fixing clip (B) into the holes on the wall successively.

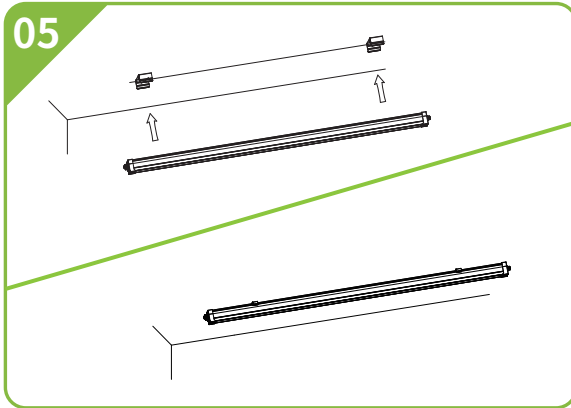

- Snap the light module into the fixing clip.

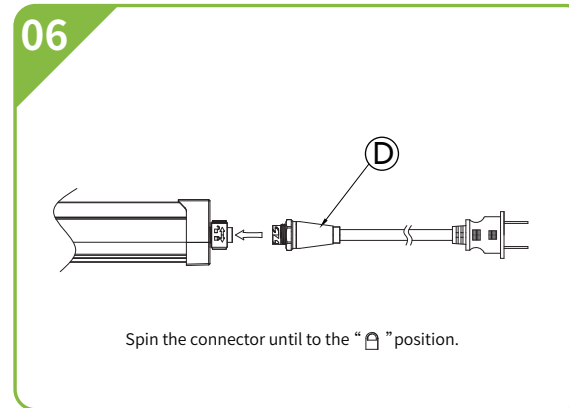

- Connect the AC cord .(D)

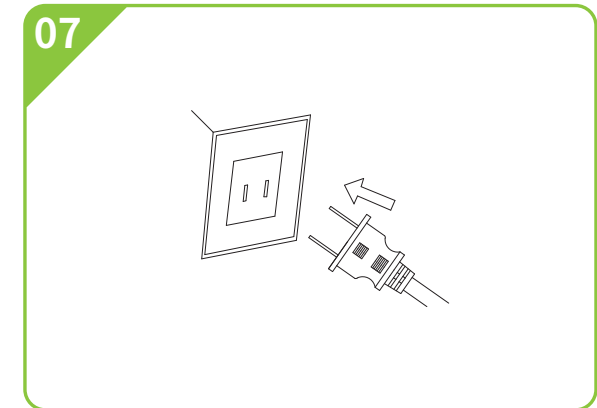

- Plug in the power.